

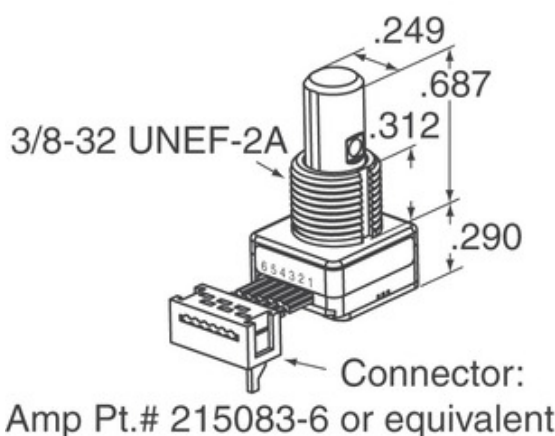

Grayhill, Inc.

62S11-H9-060SH

Număr parc:	62S11-H9-060SH
Producator / Marca:	Grayhill, Inc.
Descrierea produsului	ROTARY ENCODER OPTICAL 32PPR
Foi de date:	PDF 62S11-H9-060SH.pdf
Statutul RoHS	 Plăcuță fără plumb / Compliant cu RoHS
Barca din	Hong Kong
Calea de transport	DHL/Fedex/TNT/UPS/EMS

[CERERE DE OFERTĂ](#)

Imaginea poate fi reprezentată. Vedeți specificațiile pentru detalii despre produs.



Specificațiile 62S11-H9-060SH

NUMĂR PARC	62S11-H9-060SH
PRODUCĂTOR	Grayhill, Inc.
DESCRIERE	ROTARY ENCODER OPTICAL 32PPR
CONDIȚII LIBERE DE STARE / STARE ROHS	Plăcuță fără plumb / Compliant cu RoHS
FIȘA CU DATE	PDF 62S11-H9-060SH.pdf
TENSIUNE - APROVIZIONARE	5V
STILUL DE TERMINARE	Cable Leads
SERIE	62S
DURATA DE ROTAȚIE (CICLURI MIN)	1M
IMPULSURI PE REVOLUȚIE	32
TIPUL DE IEȘIRE	Quadrature (Incremental)
ALTE NUME	62S11H9060SH
ORIENTARE	Vertical
TIPUL DE MONTARE	Panel Mount
NIVELUL DE SENSIBILITATE LA UMIDITATE (MSL)	1 (Unlimited)
PRODUCĂTOR STANDARD TIMP DE PLUMB	8 Weeks
CONDIȚII DE STARE FĂRĂ PLUMB / STARE ROHS	Lead free / RoHS Compliant
TIPUL ENCODERULUI	Optical
DETENTEI	Yes
CONSTRUIT ÎN SWITCH	Yes
TIPUL ACTUATORULUI	1/4" Dia Flatted End

Etichete asemănătoare

Grayhill, Inc. 62S11-H9-060SH	Distribuitor 62S11-H9-060SH	Furnizor 62S11-H9-060SH
Pret 62S11-H9-060SH	Poze 62S11-H9-060SH	Imagine 62S11-H9-060SH
Fisa de date PDF 62S11-H9-060SH	Fișă de date pentru descărcare 62S11-H9-060SH	Fisa de date 62S11-H9-060SH
Stocul 62S11-H9-060SH	Cumpărați 62S11-H9-060SH	Cumpără Grayhill, Inc. 62S11-H9-060SH
Grayhill, Inc. 62S11-H9-060SH	Furnizor Grayhill, Inc.	Distribuitor Grayhill, Inc.
Grayhill, Inc. 62S11-H9-060SH	Grayhill Inc. 62S11-H9-060SH	

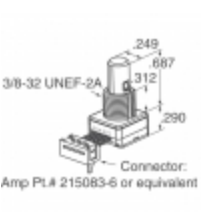
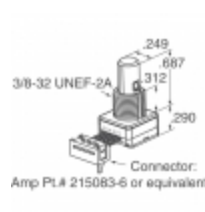
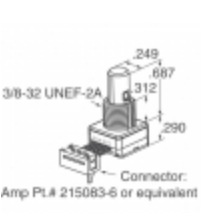
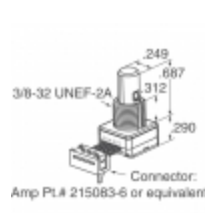
produse asemanatoare

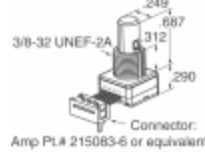
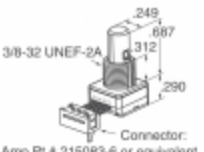
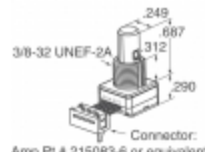
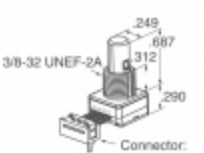
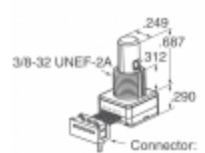
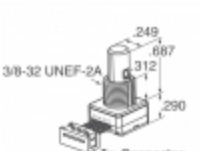
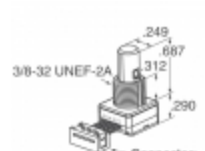
 <p>62S11-L0-040C Producători: Grayhill, Inc. Descriere: ROTARY ENCODER OPTICAL 32PPR In stoc: Out stock RFQ</p>	 <p>62S11-H9-050S Producători: Grayhill, Inc. Descriere: ROTARY ENCODER OPTICAL 32PPR In stoc: Out stock RFQ</p>
 <p>62S11-L0-020C Producători: Grayhill, Inc. Descriere: ROTARY ENCODER OPTICAL 32PPR In stoc: Out stock RFQ</p>	 <p>62S11-L0-020CH Producători: Grayhill, Inc. Descriere: ROTARY ENCODER OPTICAL 32PPR In stoc: Out stock RFQ</p>
 <p>62S11-L0-040S Producători: Grayhill, Inc. Descriere: ROTARY ENCODER OPT 32PPR 4" CBL In stoc: Out stock RFQ</p>	 <p>62S11-H9-040S Producători: Grayhill, Inc. Descriere: ROTARY ENCODER OPTICAL 32PPR In stoc: Out stock RFQ</p>
 <p>62S11-H9-020S Producători: Grayhill, Inc. Descriere: ROTARY ENCODER OPTICAL 32PPR In stoc: Out stock RFQ</p>	 <p>62S11-H9-P Producători: Grayhill, Inc. Descriere: ROTARY ENCODER OPTICAL 32PPR In stoc: Out stock RFQ</p>
 <p>62S11-H9-PH Producători: Grayhill, Inc. Descriere: ROTARY ENCODER OPTICAL 32PPR In stoc: Out stock RFQ</p>	 <p>62S11-H9-025S Producători: Grayhill, Inc. Descriere: ROTARY ENCODER OPTICAL 32PPR In stoc: Out stock RFQ</p>
 <p>62S11-H9-060C Producători: Grayhill, Inc. Descriere: ROTARY ENCODER OPTICAL 32PPR In stoc: Out stock RFQ</p>	 <p>62S11-H9-040C Producători: Grayhill, Inc. Descriere: ROTARY ENCODER OPTICAL 32PPR In stoc: Out stock RFQ</p>