

FEATURES

High gain: 47 dB
P1dB output power: 10 dBm
Saturated output power (P_{SAT}): 13 dBm
Limiting dynamic range: 40 dB minimum
Field replaceable SMA connectors
Operating temperature: -40°C to $+85^{\circ}\text{C}$

APPLICATIONS

Telecom infrastructure
Test instrumentation
Electronic warfare
Aerospace
Radar

GENERAL DESCRIPTION

The **HMC7891** is a limiting amplifier that operates over the band of 2 GHz to 18 GHz, with a high gain of 47 dB. The amplifier provides a saturated output power of 13 dBm over the input power range of -30 dBm to $+10$ dBm, for a limiting dynamic range of 40 dB.

The amplifier can also be used as a frequency tripler due to the high third harmonic output level at saturation. See Figure 14 for a plot of third harmonic levels with input signals from 2 GHz to 6 GHz with an input drive level of 10 dBm.

FUNCTIONAL BLOCK DIAGRAM

Figure 1.

13783-001

An integrated voltage regulator provides the proper bias voltage, drawing 300 mA from a single dc power supply of $8\text{ V} \pm 1\text{ V}$.

The **HMC7891** is packaged in a compact modular design with field replaceable SMA connectors.

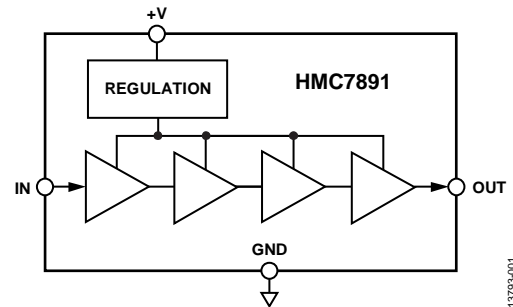
HMC7891* PRODUCT PAGE QUICK LINKS

Last Content Update: 02/23/2017

COMPARABLE PARTS

View a parametric search of comparable parts.

DOCUMENTATION

Data Sheet

- HMC7891: 2 GHz to 18 GHz Limiting Amplifier Module Data Sheet

REFERENCE MATERIALS

Press

- ADI Expands Portfolio of High Performance RF and Microwave Standard Modules to Facilitate Rapid Prototyping and Faster Time to Market

Technical Articles

- Wideband High Dynamic Range Limiting Amplifier

DESIGN RESOURCES

- HMC7891 Material Declaration
- PCN-PDN Information
- Quality And Reliability
- Symbols and Footprints

DISCUSSIONS

View all HMC7891 EngineerZone Discussions.

SAMPLE AND BUY

Visit the product page to see pricing options.

TECHNICAL SUPPORT

Submit a technical question or find your regional support number.

DOCUMENT FEEDBACK

Submit feedback for this data sheet.

TABLE OF CONTENTS

Features	1	Theory of Operation	9
Applications.....	1	Applications Information	10
Functional Block Diagram	1	RF Front-End Protection.....	10
General Description	1	Frequency Tripling.....	10
Revision History	2	Gain Equalization.....	10
Specifications.....	3	Outline Dimensions	11
Absolute Maximum Ratings.....	5	Ordering Guide	11
ESD Caution.....	5		
Pin Configuration and Function Descriptions.....	6		
Typical Performance Characteristics	7		

REVISION HISTORY

10/2016—Revision 0: Initial Version

SPECIFICATIONS

Unless otherwise noted, specifications are with a bias voltage of 8 V and a baseplate temperature of 25°C.

Table 1. 2 GHz to 6 GHz Frequency Specifications

Parameter	Min	Typ	Max	Unit	Test Conditions/Comments
FREQUENCY RANGE	2		6	GHz	
GAIN					
Small Signal Gain	43	47		dB	–45 dBm input
Gain Flatness (\pm)		2.0		dB	Total flatness over 2 GHz to 18 GHz
RADIO FREQUENCY (RF) OUTPUT POWER					
1 dB Compression (P1dB)	7	10	13	dBm	
Saturated Output Power (P_{SAT})	10	13	16	dBm	
Limiting Dynamic Range	40			dB	–30 dBm to +10 dBm input
Second Harmonic		–18		dBc	2 GHz to 3 GHz input, output at P_{SAT}
Third Harmonic		–14		dBc	2 GHz input, output at P_{SAT}
Noise Figure		3.4		dB	
RETURN LOSS					
Input		15		dB	Small signal operation
Output		22		dB	
DC POWER					
Input Voltage	7.0	8.0	9.0	V	
Current		0.3	0.4	A	

Table 2. 6 GHz to 12 GHz Frequency Specifications

Parameter	Min	Typ	Max	Unit	Test Conditions/Comments
FREQUENCY RANGE	6		12	GHz	
GAIN					
Small Signal Gain	43	48		dB	–45 dBm input
Gain Flatness (\pm)		2.0		dB	Total flatness over 2 GHz to 18 GHz
RF OUTPUT POWER					
1 dB Compression (P1dB)	7	11	14	dBm	
Saturated Output Power (P_{SAT})	10	14	17	dBm	
Limiting Dynamic Range	40			dB	–30 dBm to +10 dBm input
Second Harmonic		–15		dBc	3 GHz to 6 GHz input, output at P_{SAT}
Third Harmonic		–14		dBc	2 GHz to 4 GHz input, output at P_{SAT}
Noise Figure		2.8		dB	
RETURN LOSS					
Input		19		dB	Small signal operation
Output		23		dB	
DC POWER					
Input Voltage	7.0	8.0	9.0	V	
Current		0.3	0.4	A	

Table 3. 12 GHz to 18 GHz Frequency Specifications

Parameter	Min	Typ	Max	Unit	Test Conditions/Comments
FREQUENCY RANGE	12		18	GHz	
GAIN					
Small Signal Gain	43	48		dB	–45 dBm input
Gain Flatness (\pm)		2.0		dB	Total flatness over 2 GHz to 18 GHz
RF OUTPUT POWER					
1 dB Compression (P1dB)	7	11	14	dBm	–30 dBm to +10 dBm input 6 GHz to 9 GHz input, output at P _{SAT} 4 GHz to 6 GHz input, output at P _{SAT}
Saturated Output Power (P _{SAT})	10	14	17	dBm	
Limiting Dynamic Range	40			dB	
Second Harmonic		–15		dBc	
Third Harmonic		–8		dBc	
Noise Figure		3.5		dB	
RETURN LOSS					
Input		17		dB	Small signal operation
Output		15		dB	
DC POWER					
Input Voltage	7.0	8.0	9.0	V	
Current		0.3	0.4	A	

ABSOLUTE MAXIMUM RATINGS

Table 4.

Parameter	Rating
8 V Bias Line	10 V
RF Input Level	15 dBm
Operating Temperature Range	-40°C to +85°C
Storage Temperature Range	-65°C to +150°C
EDS Rating (HBM)	Class 1A

Stresses at or above those listed under Absolute Maximum Ratings may cause permanent damage to the product. This is a stress rating only; functional operation of the product at these or any other conditions above those indicated in the operational section of this specification is not implied. Operation beyond the maximum operating conditions for extended periods may affect product reliability.

ESD CAUTION



ESD (electrostatic discharge) sensitive device. Charged devices and circuit boards can discharge without detection. Although this product features patented or proprietary protection circuitry, damage may occur on devices subjected to high energy ESD. Therefore, proper ESD precautions should be taken to avoid performance degradation or loss of functionality.

PIN CONFIGURATION AND FUNCTION DESCRIPTIONS

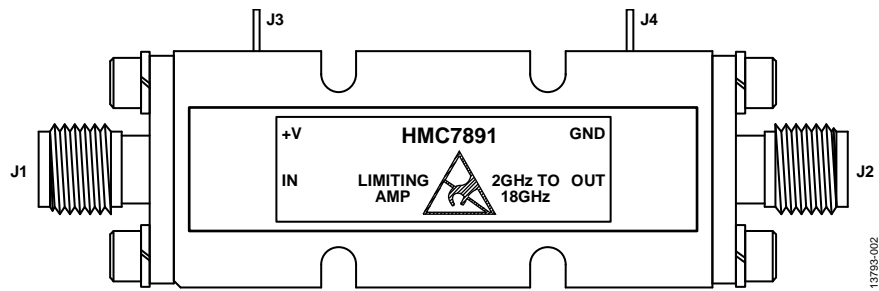

Figure 2. Pin Configuration

Table 5. Pin Function Descriptions

Pin No.	Mnemonic	Description
J1	IN	RF Input. IN has a frequency range of 2 GHz to 18 GHz, and an input signal maximum of 15 dBm.
J2	OUT	RF Output. OUT has a frequency range of 2 GHz to 18 GHz.
J3	+V	8 V Input Supply.
J4	GND	Ground Connection.

TYPICAL PERFORMANCE CHARACTERISTICS

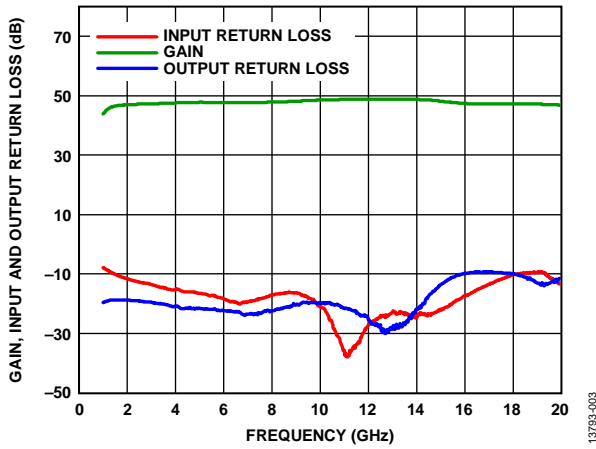

Figure 3. Gain, Input Return Loss, and Output Return Loss vs. Frequency at 25°C

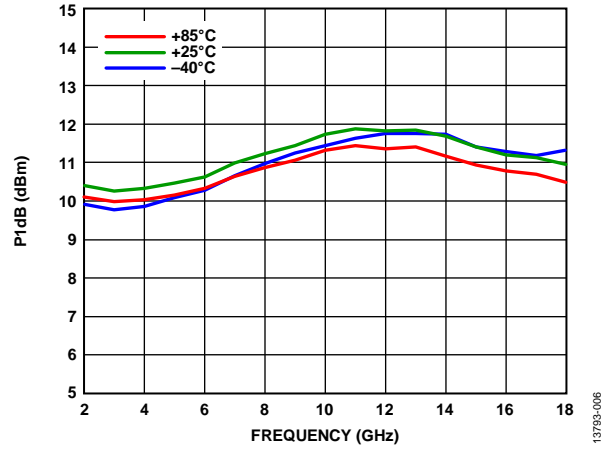

Figure 6. P1dB vs. Frequency for Various Temperatures

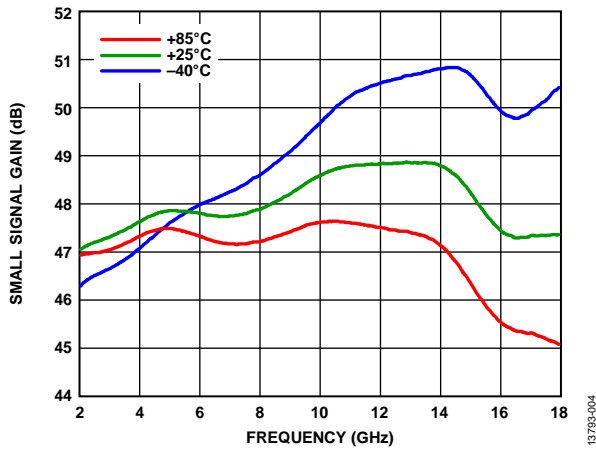

Figure 4. Small Signal Gain vs. Frequency for Various Temperatures

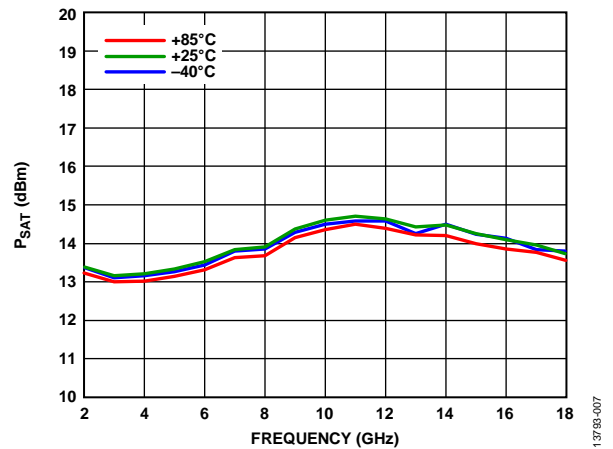

Figure 7. Saturated Power (P_{SAT}) vs. Frequency for Various Temperatures

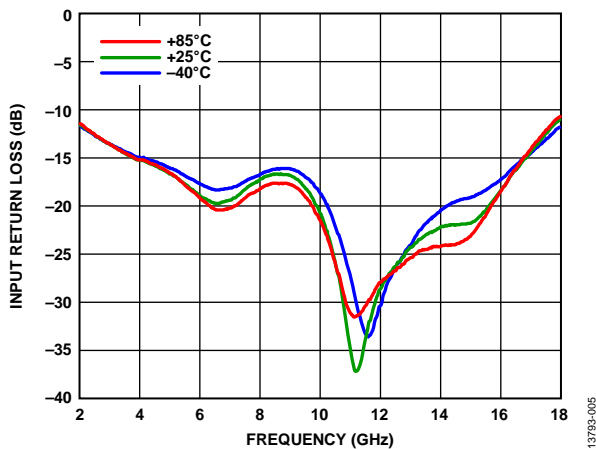

Figure 5. Input Return Loss vs. Frequency for Various Temperatures

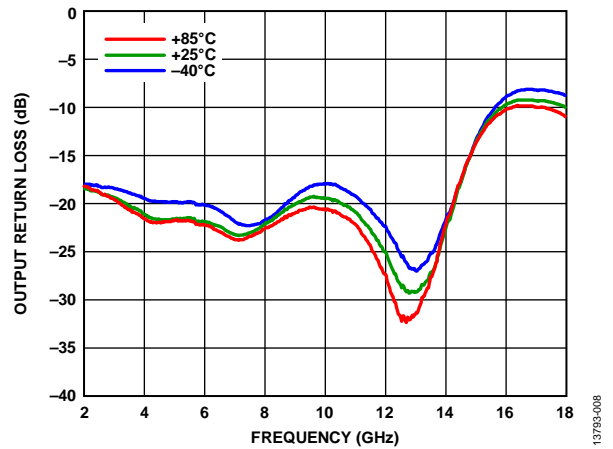

Figure 8. Output Return Loss vs. Frequency for Various Temperatures

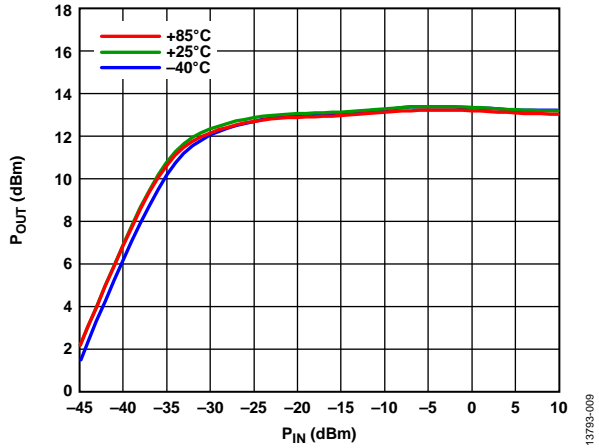

Figure 9. Output Power (P_{OUT}) vs. Input Power (P_{IN}) at 2 GHz for Various Temperatures

13793-009

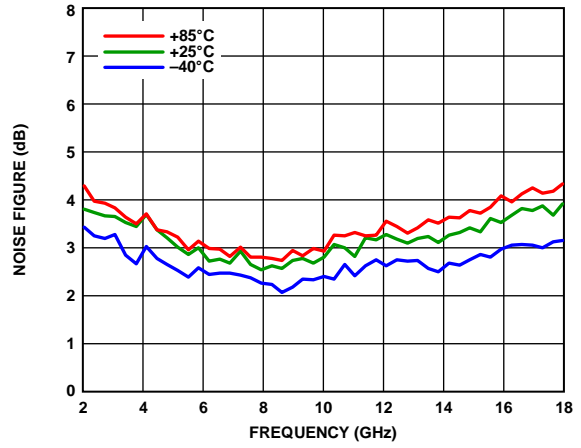

Figure 12. Noise Figure vs. Frequency for Various Temperatures

13793-012

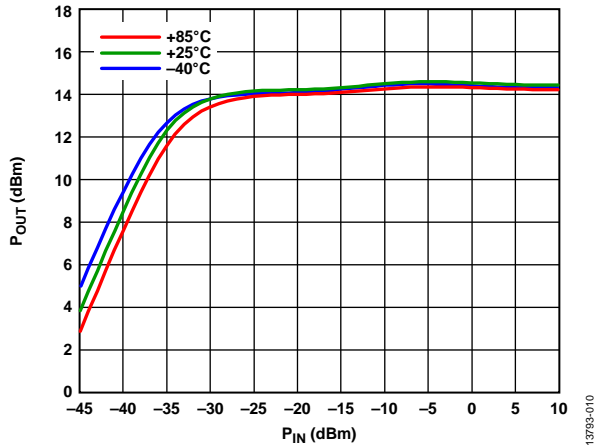

Figure 10. Output Power (P_{OUT}) vs. Input Power (P_{IN}) at 10 GHz for Various Temperatures

13793-010

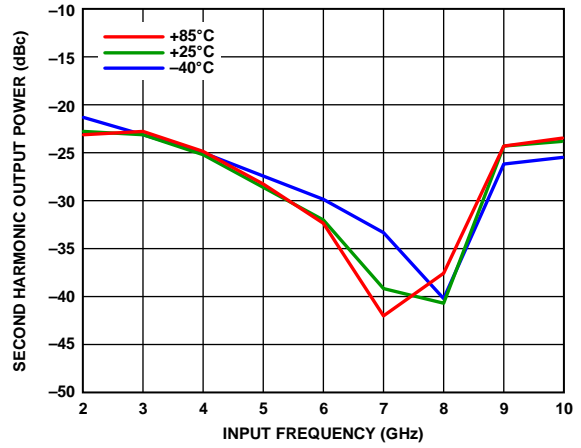

Figure 13. Second Harmonic Output Power (P_2) vs. Input Frequency for Various Temperatures, Input Power = 10 dBm

13793-013

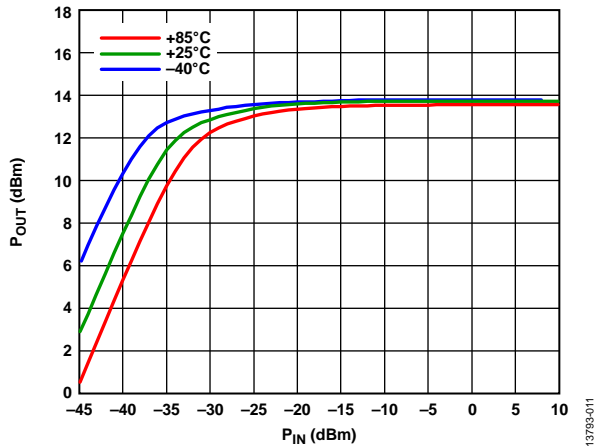

Figure 11. Output Power (P_{OUT}) vs. Input Power (P_{IN}) at 18 GHz for Various Temperatures

13793-011

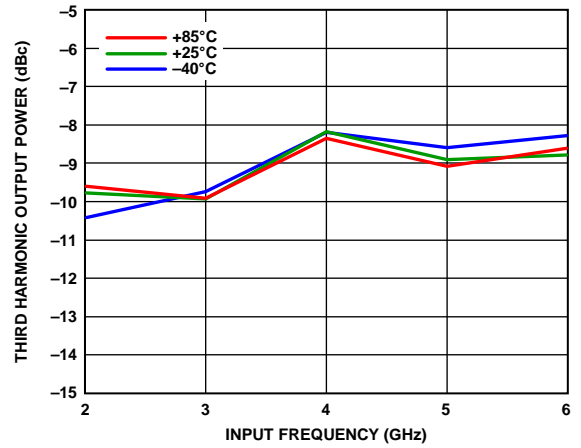

Figure 14. Third Harmonic Output Power (P_3) vs. Input Frequency for Various Temperatures, Input Power = 10 dBm

13793-014

THEORY OF OPERATION

The HMC7891 multistage amplifier is designed to be mounted to a heat sink of a suitable size such that during operation, the backside case temperature never exceeds 85°C. Operation of the unit at backside case temperatures greater than 85°C results in the reduced life of the unit.

Before applying dc voltages, provide both the RF input and output with 50 Ω connections or terminations. Never disconnect the RF output when dc voltage is applied to the unit.

The unit is designed to be operated over a voltage range of 7 V to 9 V dc (8 V dc nominal). Providing less than 7 V can result in failure of the internal regulator to generate the proper voltage. Providing greater than 9 V increases the risk of overheating.

The amplifier is operational whenever the dc voltage is applied. There is no additional control circuitry.

The maximum current specification is 0.4 A. The power supply must be capable of providing that much current.

To turn on the amplifier, complete the following steps:

1. Verify that the dc connections are correct.
2. Verify that the RF input is off.
3. Apply 7 V to 9 V dc voltage to the +V pin.
4. Apply the RF input, ensuring that the power level is less than 10 dBm.

To turn off the amplifier, complete the following steps:

1. Turn the RF input off.
2. Turn off the dc supply.

APPLICATIONS INFORMATION

RF FRONT-END PROTECTION

The [HMC7891](#) is suitable for use in the front end of a wide variety of RF systems, with an input limiting range of -30 dBm to $+10$ dBm built in, removing the need for an additional standalone limiter to protect other components in the system.

With a low noise figure of 3.5 dB, a high gain of 47 dB, and a wide bandwidth of 2 GHz to 18 GHz, the [HMC7891](#) is well suited for modern radar, communications, electronic warfare, and multifunction systems.

FREQUENCY TRIPLING

When the [HMC7891](#) is driven into hard saturation, the limiting response creates a strong third harmonic at the output. Figure 14 shows the typical third harmonic output levels relative to the fundamental output tone. The [HMC7891](#) can be used as a wideband analog frequency tripler due to this response.

As an example, an input tone at 4 GHz with a power level of 10 dBm produces a 13 dBm fundamental output tone at 4 GHz, as well as a third harmonic at approximately 4.5 dBm (-8.5 dBc) at 12 GHz. The RF output can then be followed with a band-pass filter centered at 12 GHz to filter out the fundamental output and other harmonics.

GAIN EQUALIZATION

Many wideband RF components have an undesirable amount of gain variation or negative gain slope over frequency. Components and systems requiring gain equalization can be connected to the input of the [HMC7891](#), resulting in a flatter response.

The limiting amplifier output saturates with inputs ranging from -30 dBm to $+10$ dBm for a total limiting dynamic range of 40 dB. The saturated output power is flat over frequency and temperature, making the [HMC7891](#) a versatile equalizer suitable for a variety of environments.

OUTLINE DIMENSIONS

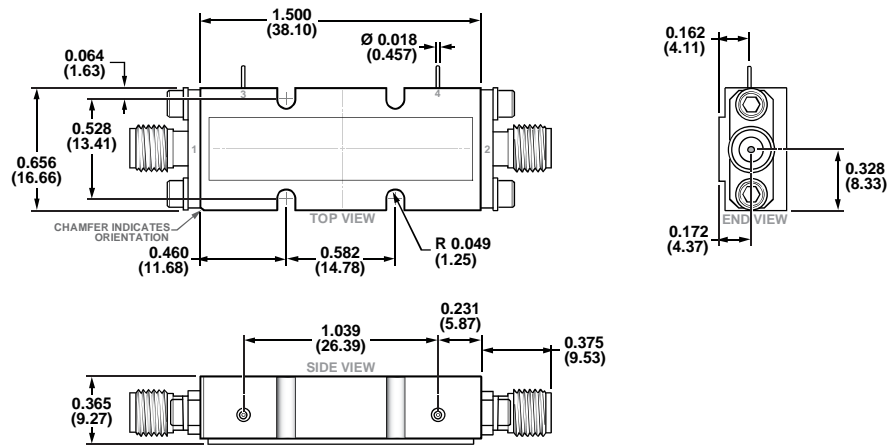

CONTROLLING DIMENSIONS ARE IN INCHES; MILLIMETER DIMENSIONS (IN PARENTHESES) ARE ROUNDED-OFF INCH EQUIVALENTS FOR REFERENCE ONLY AND ARE NOT APPROPRIATE FOR USE IN DESIGN.

Figure 15. 4-Lead Module with Connector Interface [MODULE] (ML-4-2)

Dimensions shown in inches and [millimeters]

ORDERING GUIDE

Model	Temperature Range	Package Description	Package Option
HMC7891	-40°C to +85°C	4-Lead Module with Connector Interface [MODULE]	ML-4-2