

## AC/DC Converter

### Non-Isolation Buck Converter PWM method Output 2.6W 15V

# BM2P159T1F Reference Board

## BM2P159T1F-EVK-001

The BM2P159T1F-EVK-001 evaluation board outputs 15V voltage from the input of 90Vac to 264Vac. The output current supplies up to 0.175A. BM2P109TF which is PWM method DC/DC converter IC built-in 650V MOSFET is used.

The BM2P159T1F contributes to low power consumption by built-in a 650 V starting circuit. Built-in current detection resistor realizes compact power supply design.

Current mode control imposes current limitation on every cycle, providing superior performance in bandwidth and transient response. The switching frequency is 100 kHz in fixed mode. At light load, frequency is reduced and high efficiency is realized. Built-in frequency hopping function contributes to low EMI. Low on-resistance 9.5  $\Omega$  650 V MOSFET built-in contributes to low power consumption and easy design.

The flywheel diode is a fast recovery diode of 1A/650 V RFN1LAM6S, contributing to low power consumption.

## Electronics Characteristics

Not guarantee the characteristics, is representative value.

Unless otherwise noted : $V_{IN} = 230Vac$ ,  $I_{OUT} = 175mA$ ,  $T_a:25^{\circ}C$

Parameter	Min	Typ	Max	Units	Conditions
Input Voltage Range	90	230	264	Vac	
Input Frequency	47	50/60	63	Hz	
Output Voltage	13.5	15.0	16.5	V	
Maximum Output Power	-	-	2.625	W	$I_{OUT} = 175mA$
Output Current Range (NOTE1)	2	175	175	mA	
Stand-by Power	-	40	-	mW	$I_{OUT} = 0A$
Efficiency	-	81.0	-	%	
Output Ripple Voltage (NOTE2)	-	31	-	mVpp	
Operating Temperature Range	-10	25	65	$^{\circ}C$	

(NOTE1) Please adjust operating time, within any parts surface temperature under 105 $^{\circ}C$

(NOTE2) Not include spike noise

## Operation Procedure

### 1. Operation Equipment

- (1) AC Power supply 90Vac~264Vac, over 10W
- (2) Electronic Load capacity 0.175A
- (3) Multi meter

### 2. Connect method

- (1) AC power supply presetting range 90~264Vac, Output switch is off.
- (2) Load setting under 0.175A. Load switch is off.
- (3) AC power supply N terminal connect to the board AC (N) of CN1, and L terminal connect to AC(L).
- (4) Load + terminal connect to VOUT1, GND terminal connect to GND1 terminal
- (5) AC power meter connect between AC power supply and board.
- (6) Output test equipment connects to output terminal
- (7) AC power supply switch ON.
- (8) Check that output voltage is 15V.
- (9) Electronic load switch ON
- (10) Check output voltage drop by load connect wire resistance



CN1 : from the top ①:AC (L), ②:AC (N)

Figure 1. Connection Circuit

## Deleting

Maximum Output Power  $P_o$  of this reference board is 2.625W. The derating curve is shown on the right.

if ambient temperature is over 50°C, please adjust load continuous time by over 105°C of any parts surface temperature.

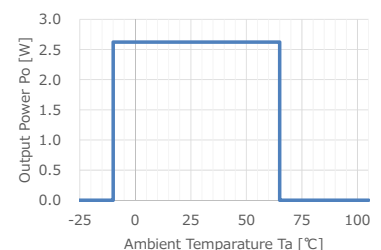

Figure 2. Temperature Derating curve

### Schematics

$V_{IN} = 90\sim 264V_{ac}$ ,  $V_{OUT} = 15V$

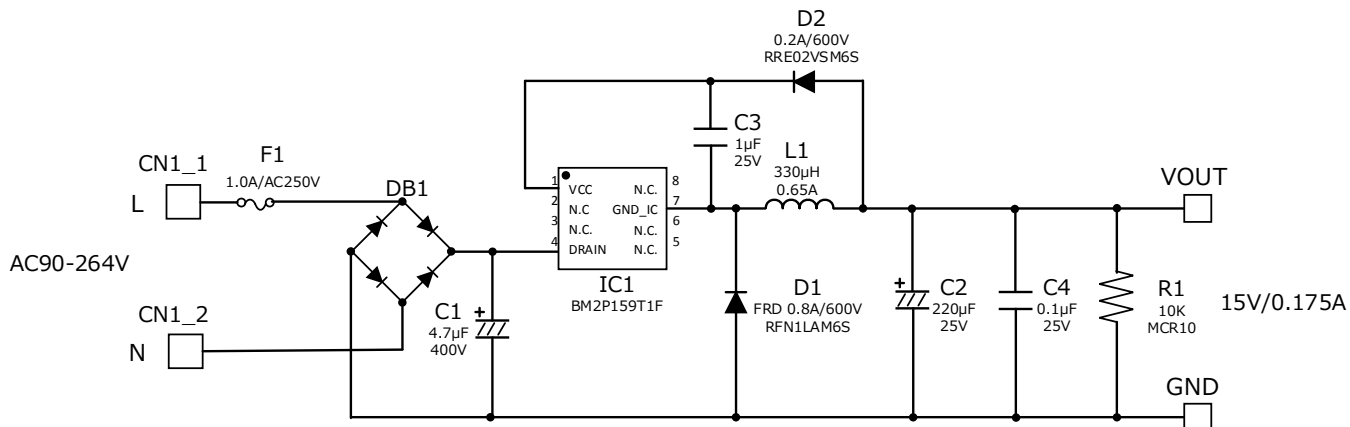

Figure 3. BM2P159T1F-EVK-001 Schematics

### Bill of Materials

Table 1. BoM of BM2P159T1F-EVK-001

Part Reference	Qty.	Type	Value	Description	Part Number	Manufacture	Configuration mm (inch)
C1	1	Electrolytic	4.7µF	400V, ±20%	860 021 374 008	Würth	-
C2	1	Electrolytic	220µF	25VV, ±20%	860 080 474 010	Würth	-
C3	1	Ceramic	1µF	25V, X7R, ±20%	TMK107B7105MA-T	Taiyo Yuden	1608 (0603)
C4	1	Ceramic	0.1µF	50V, X7R, ±20%	HMK107B7104MA-T	Taiyo Yuden	1608 (0603)
CN1	1	Connector	-	2pin	B2P-VH	JST	-
D1	1	FRD	0.8A	600V	RFN1LAM6S TR	ROHM	PMDS
D2	1	Diode	0.2A	600V	RRE02VSM6S	ROHM	TUMD2SM
DB1	1	Bridge	1A	800V	D1UBA80-7062	Shindengen	SOPA-4
F1	1	Fuse	1A	250V	39211000000	Littelfuse	-
IC1	1	AC/DC Converter	-	-	BM2P159T1F	ROHM	SOP8
L1	1	Coil	330µH	0.65A	744 731 331	Würth	-
R1	1	Resistor	10kΩ	0.1W, ±5%	MCR10EZPJ103	ROHM	2012 (0805)

PCB

Size : 18 mm x 40 mm

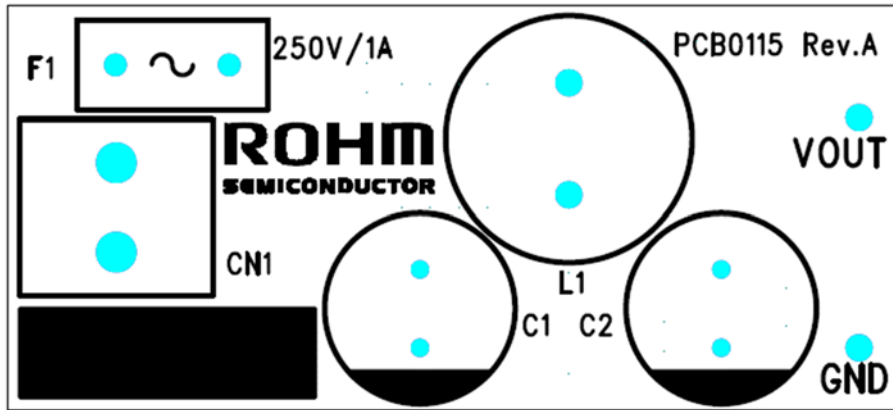

Figure 4. Top Silkscreen (Top view)

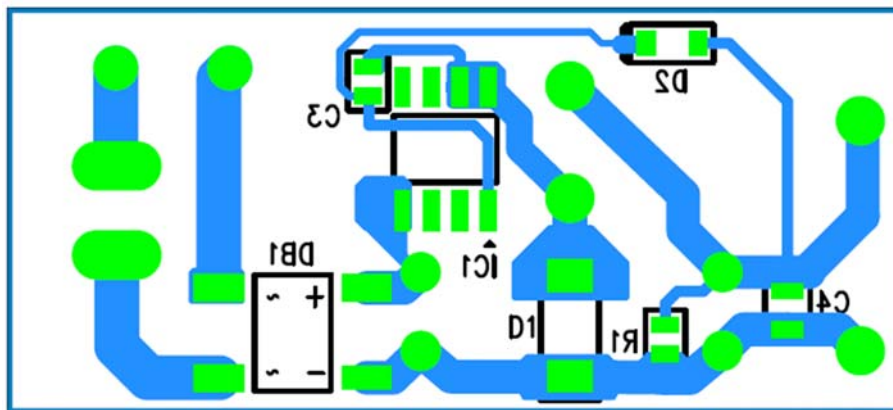

Figure 5. Bottom Layout (Top view)

Performance Data

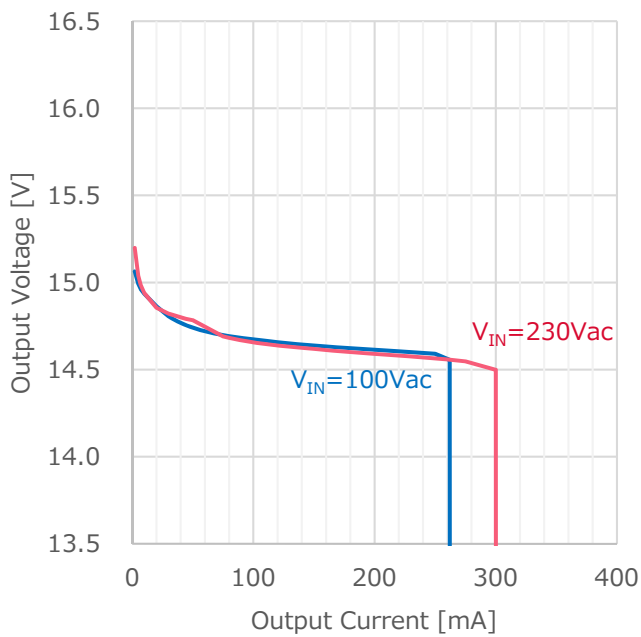

Figure 6. Load Regulation ( $I_{OUT}$  vs.  $V_{OUT}$ )

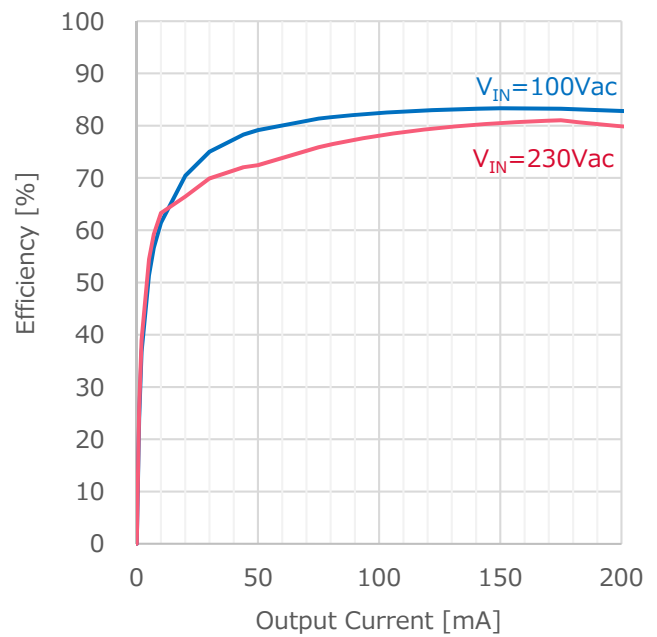

Figure 7. LOAD Regulation ( $I_{OUT}$  vs. Efficiency)

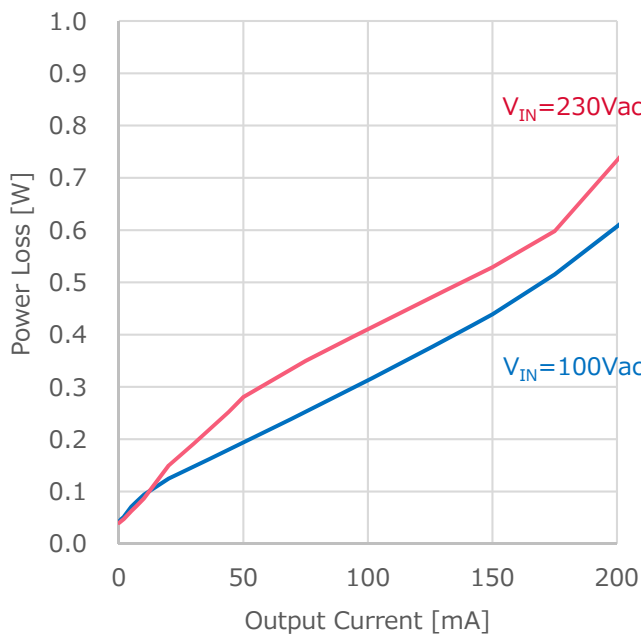

Figure 8. Load Regulation ( $I_{OUT}$  vs.  $P_{LOSS}$ )

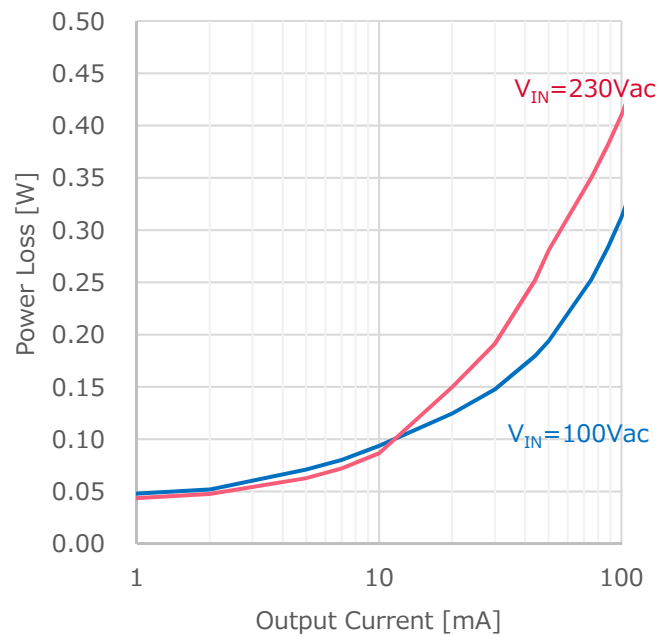

Figure 9. LOAD Regulation ( $I_{OUT}$  vs.  $P_{LOSS}$ )

Table 2. Load Regulation ( $V_{IN}=100Vac$ )

$I_{OUT}$	$V_{OUT}$	Efficiency
44 mA	14.756 V	78.32 %
88 mA	14.684 V	81.99 %
132 mA	14.650 V	83.14 %
175 mA	14.626 V	83.24 %

Table 3. Load Regulation ( $V_{IN}=230Vac$ )

$I_{OUT}$	$V_{OUT}$	Efficiency
44 mA	14.792 V	72.08 %
88 mA	14.671 V	77.17 %
132 mA	14.630 V	79.87 %
175 mA	14.604 V	81.03 %

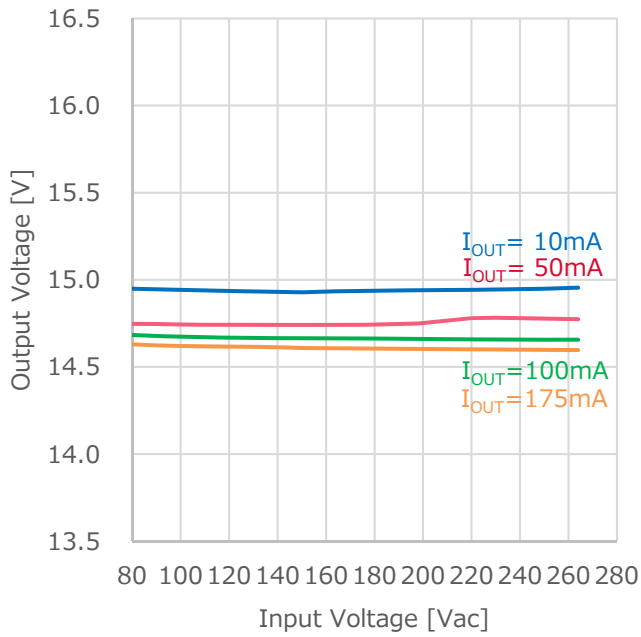

Figure 10. LINE Regulation ( $I_{OUT}$  vs.  $V_{OUT}$ )

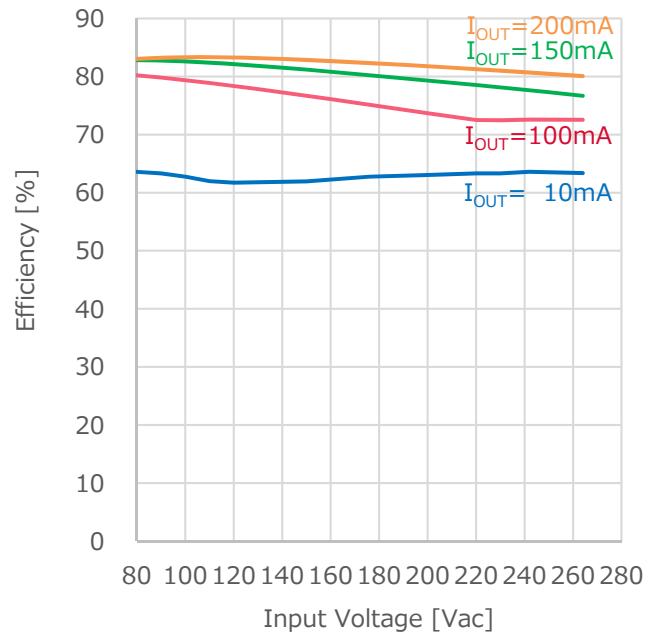

Figure 11. LINE Regulation ( $I_{OUT}$  vs. Efficiency)

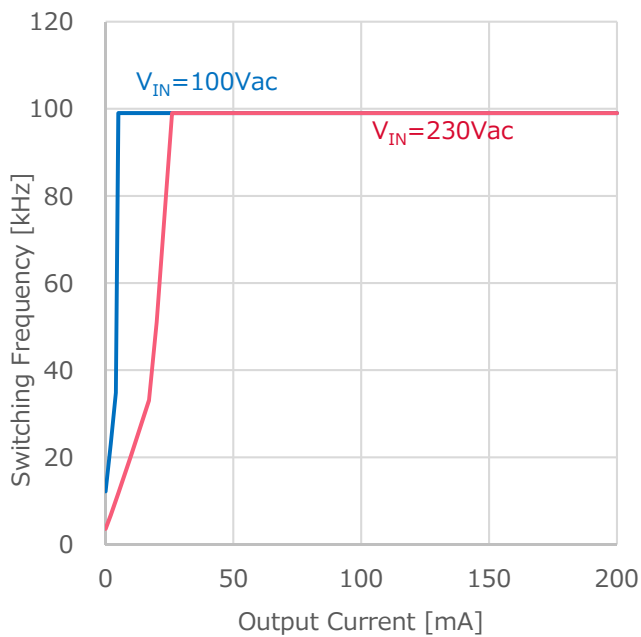

Figure 12. Switching Frequency ( $I_{OUT}$  vs.  $F_{SW}$ )

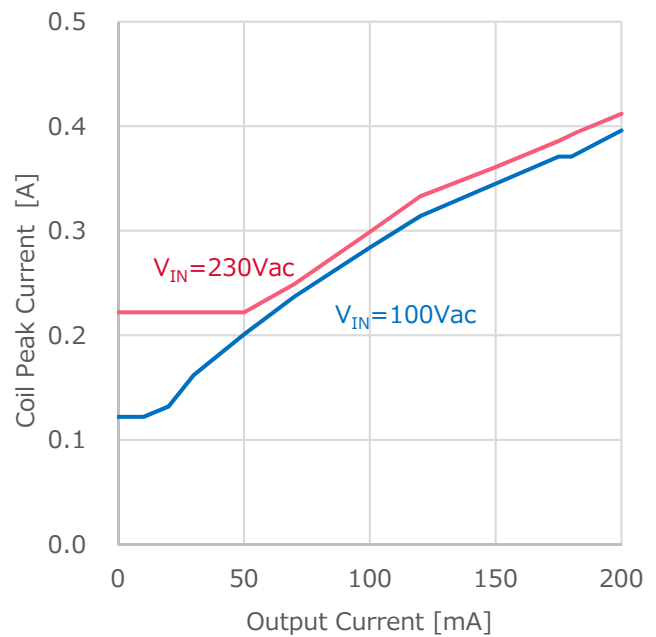

Figure 13. Coil Peak Current ( $I_{OUT}$  vs.  $I_{peak}$ )

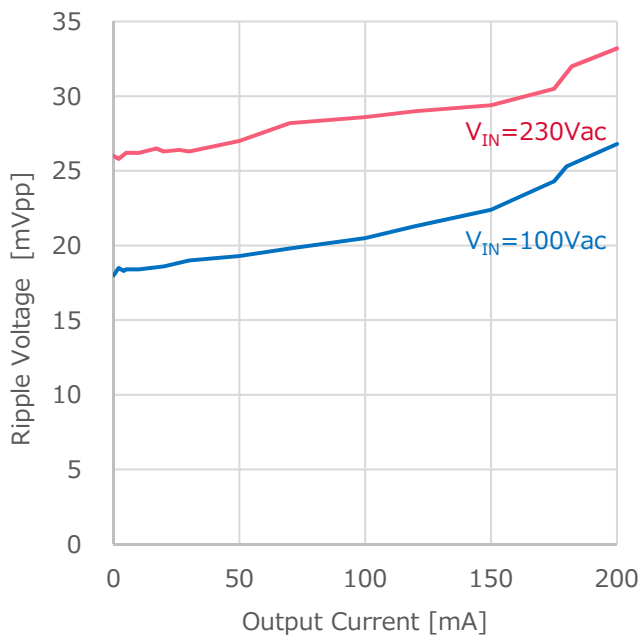
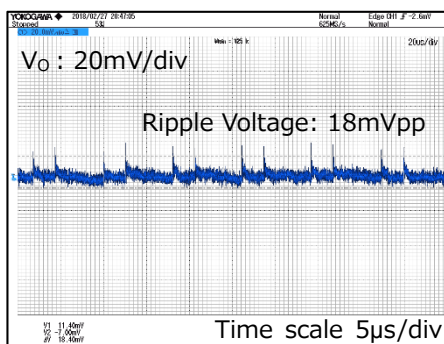
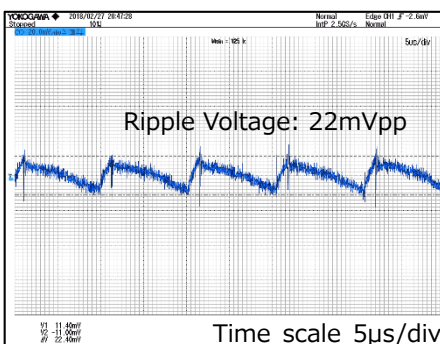

Figure 14. VOUT Ripple Voltage ( $I_{OUT}$  vs.  $V_{ripple}$ )



$V_{IN}=100Vac, I_{OUT}=10mA$

Figure 15. VOUT Ripple Voltage.1



$V_{IN}=100Vac, I_{OUT}=150mA$

Figure 16. VOUT Ripple Voltage.2

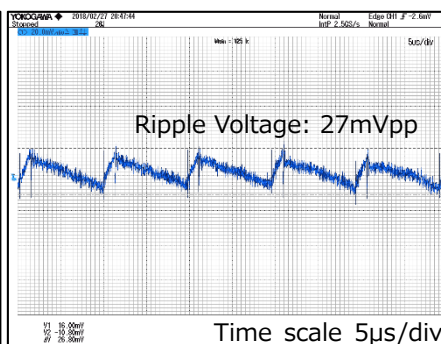

$V_{IN}=100Vac, I_{OUT}=175mA$

Figure 17. VOUT Ripple Voltage.3

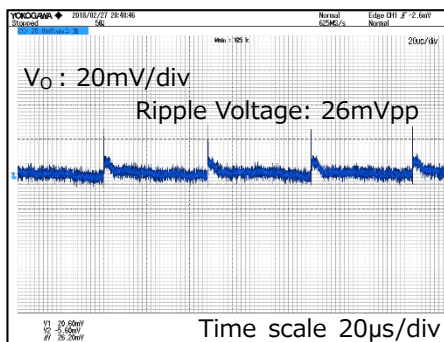

$V_{IN}=230Vac, I_{OUT}=10mA$

Figure 18. VOUT Ripple Voltage.4

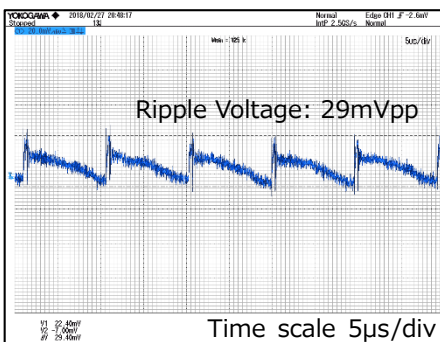

$V_{IN}=230Vac, I_{OUT}=150mA$

Figure 19. VOUT Ripple Voltage.5

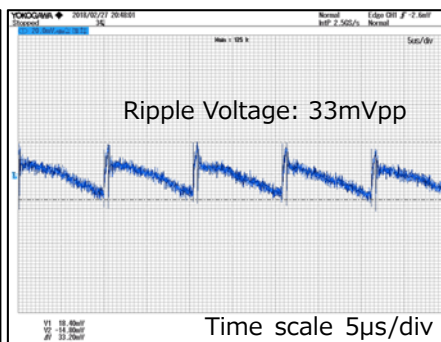

$V_{IN}=230Vac, I_{OUT}=175mA$

Figure 20. VOUT Ripple Voltage.6

Table 4. Parts surface temperature

※Ta:25°C, measured 30minutes after startup

Part	Condition	
	V <sub>IN</sub> =90Vac, I <sub>OUT</sub> =0.175A	V <sub>IN</sub> =264Vac, I <sub>OUT</sub> =0.175A
IC1	54.0°C	64.3°C
D1	56.3°C	61.3°C
L1	54.3°C	64.9°C



## Notes

- 1) The information contained herein is subject to change without notice.
- 2) Before you use our Products, please contact our sales representative and verify the latest specifications :
- 3) Although ROHM is continuously working to improve product reliability and quality, semiconductors can break down and malfunction due to various factors.  
Therefore, in order to prevent personal injury or fire arising from failure, please take safety measures such as complying with the derating characteristics, implementing redundant and fire prevention designs, and utilizing backups and fail-safe procedures. ROHM shall have no responsibility for any damages arising out of the use of our Products beyond the rating specified by ROHM.
- 4) Examples of application circuits, circuit constants and any other information contained herein are provided only to illustrate the standard usage and operations of the Products. The peripheral conditions must be taken into account when designing circuits for mass production.
- 5) The technical information specified herein is intended only to show the typical functions of and examples of application circuits for the Products. ROHM does not grant you, explicitly or implicitly, any license to use or exercise intellectual property or other rights held by ROHM or any other parties. ROHM shall have no responsibility whatsoever for any dispute arising out of the use of such technical information.
- 6) The Products specified in this document are not designed to be radiation tolerant.
- 7) For use of our Products in applications requiring a high degree of reliability (as exemplified below), please contact and consult with a ROHM representative : transportation equipment (i.e. cars, ships, trains), primary communication equipment, traffic lights, fire/crime prevention, safety equipment, medical systems, servers, solar cells, and power transmission systems.
- 8) Do not use our Products in applications requiring extremely high reliability, such as aerospace equipment, nuclear power control systems, and submarine repeaters.
- 9) ROHM shall have no responsibility for any damages or injury arising from non-compliance with the recommended usage conditions and specifications contained herein.
- 10) ROHM has used reasonable care to ensure the accuracy of the information contained in this document. However, ROHM does not warrants that such information is error-free, and ROHM shall have no responsibility for any damages arising from any inaccuracy or misprint of such information.
- 11) Please use the Products in accordance with any applicable environmental laws and regulations, such as the RoHS Directive. For more details, including RoHS compatibility, please contact a ROHM sales office. ROHM shall have no responsibility for any damages or losses resulting non-compliance with any applicable laws or regulations.
- 12) When providing our Products and technologies contained in this document to other countries, you must abide by the procedures and provisions stipulated in all applicable export laws and regulations, including without limitation the US Export Administration Regulations and the Foreign Exchange and Foreign Trade Act.
- 13) This document, in part or in whole, may not be reprinted or reproduced without prior consent of ROHM.



Thank you for your accessing to ROHM product informations.  
More detail product informations and catalogs are available, please contact us.

## ROHM Customer Support System

<http://www.rohm.com/contact/>

## ■<High Voltage Safety Precautions>

◇ Read all safety precautions before use

Please note that this document covers only the BM2P159T1F evaluation board (BM2P159T1F-EVK-001) and its functions. For additional information, please refer to the datasheet.

### To ensure safe operation, please carefully read all precautions before handling the evaluation board



Depending on the configuration of the board and voltages used,

#### **Potentially lethal voltages may be generated.**

Therefore, please make sure to read and observe all safety precautions described in the red box below.

#### **Before Use**

- [1] Verify that the parts/components are not damaged or missing (i.e. due to the drops).
- [2] Check that there are no conductive foreign objects on the board.
- [3] Be careful when performing soldering on the module and/or evaluation board to ensure that solder splash does not occur.
- [4] Check that there is no condensation or water droplets on the circuit board.

#### **During Use**

- [5] Be careful to not allow conductive objects to come into contact with the board.
- [6] **Brief accidental contact or even bringing your hand close to the board may result in discharge and lead to severe injury or death.**  
**Therefore, DO NOT touch the board with your bare hands or bring them too close to the board.**  
In addition, as mentioned above please exercise extreme caution when using conductive tools such as tweezers and screwdrivers.
- [7] If used under conditions beyond its rated voltage, it may cause defects such as short-circuit or, depending on the circumstances, explosion or other permanent damages.
- [8] Be sure to wear insulated gloves when handling is required during operation.

#### **After Use**

- [9] The ROHM Evaluation Board contains the circuits which store the high voltage. Since it stores the charges even after the connected power circuits are cut, please discharge the electricity after using it, and please deal with it after confirming such electric discharge.
- [10] Protect against electric shocks by wearing insulated gloves when handling.

This evaluation board is intended for use only in research and development facilities and should be handled **only by qualified personnel familiar with all safety and operating procedures.**

We recommend carrying out operation in a safe environment that includes the use of high voltage signage at all entrances, safety interlocks, and protective glasses.